

# >>Emergency Response Guide

smart fortwo electric drive (as of 05/2012)

Model Series 451





# Overall vehicle • Overview

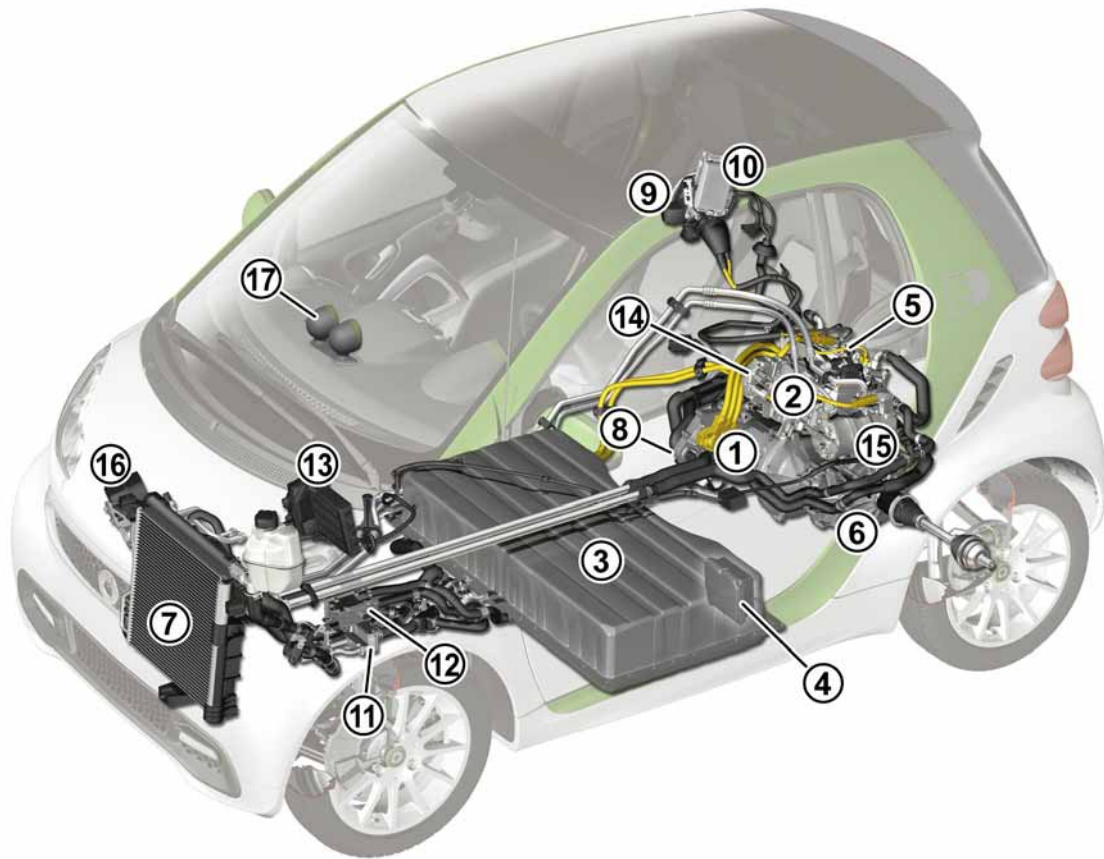

smart fortwo electric drive coupé

P00.00-4813-00

- |  |  |
|--|--|
| 1 Electric motor                         | 10 Drivetrain control unit                                   |
| 2 Power electronics control unit         | 11 High-voltage battery heat exchanger (chiller)             |
| 3 High-voltage battery                   | 12 High-voltage battery heater                               |
| 4 Battery management system control unit | 13 Interior high-voltage PTC heater                          |
| 5 On-board charger                       | 14 High-voltage adapter plate fuse box                       |
| 6 Transmission                           | 15 Electric refrigerant compressor                           |
| 7 Cooling module                         | 16 Electric vehicle sound generator                          |
| 8 Brake booster vacuum pump              | 17 Display device for battery state of charge and power flow |
| 9 Charger feed-in socket                 |  |

Model	Max. Voltage	Motor
smart fortwo electric drive coupé	391 V	Permanently energized 3-phase AC motor
smart fortwo electric drive cabrio	391 V	Permanently energized 3-phase AC motor

# Rescue data sheets

smart fortwo coupé electric drive, Typ 451

as of 05/2012

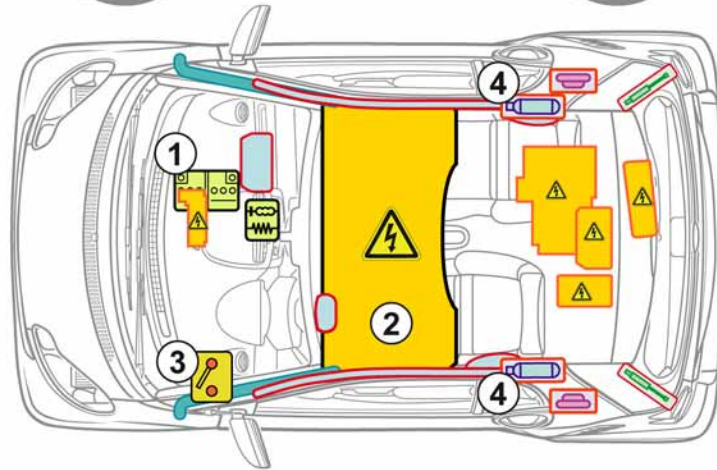
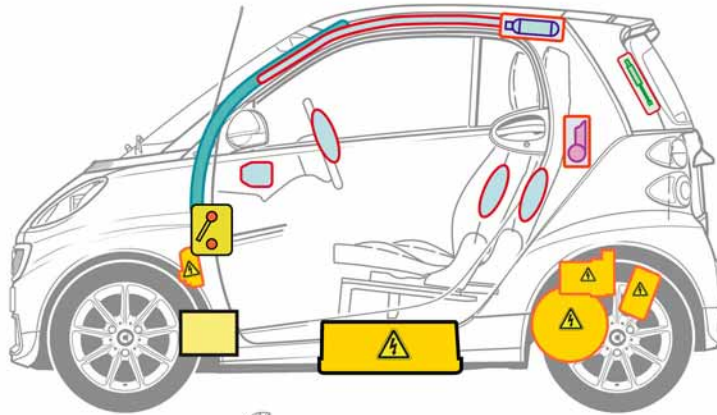

- 1 Battery (12 V)
- 2 High-voltage battery
- 3 High-voltage disconnect
- 4 Windowbag (USA only)

## Legend

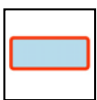

Airbag

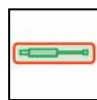

Gas filled spring device

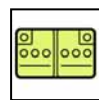

Battery (12 V)



High-voltage battery



Gas generator



Structural reinforcements



Restraint systems control unit



High-voltage components

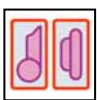

Seat belt tensioner



High-voltage disconnect

# Rescue data sheets

smart fortwo cabrio electric drive, Typ 45 1

as of 05/2012

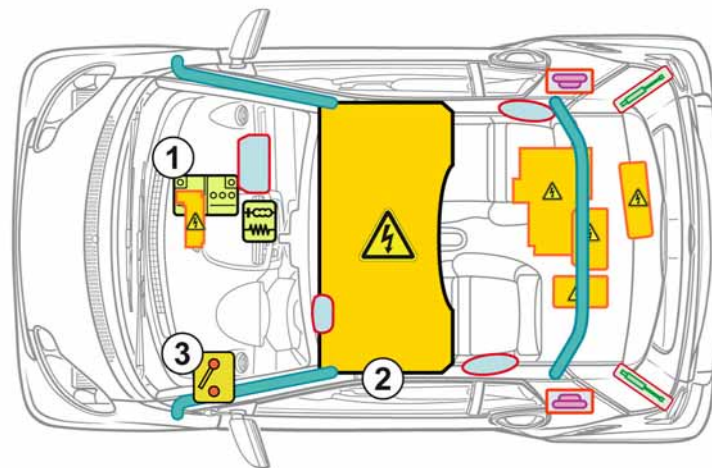
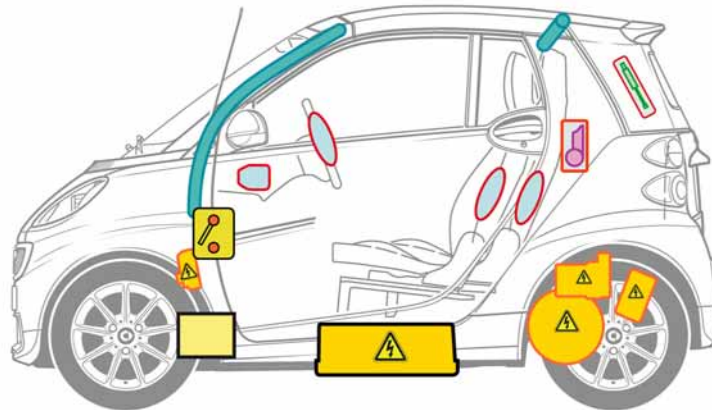

- 1 Battery (12 V)
- 2 High-voltage battery
- 3 High-voltage disconnect

## Legend



Airbag



Gas filled spring device



Battery (12 V)



High-voltage battery

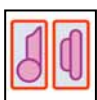

Seat belt tensioner



Structural reinforcements

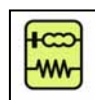

Restraint systems control unit



High-voltage components



High-voltage disconnect

# Vehicle identification

## Identifying smart electric drive vehicles

A quick vehicle identification not only optimizes the operational sequence, it also increases the safety of all participants.

The following identifying features indicate that the vehicle is a smart with an electric drive system:

- Electric drive label on the A-pillar right/left
- Electric drive logo on the B-pillar right/left
- No exhaust system
- High-voltage charging plug behind the fuel flap
- High-voltage battery state of charge (SOC) and power flow display devices on the dashboard
- Orange high-voltage cables in the engine compartment
- High-voltage components with warning label



Rear view, no exhaust system

P00.00-4998-00

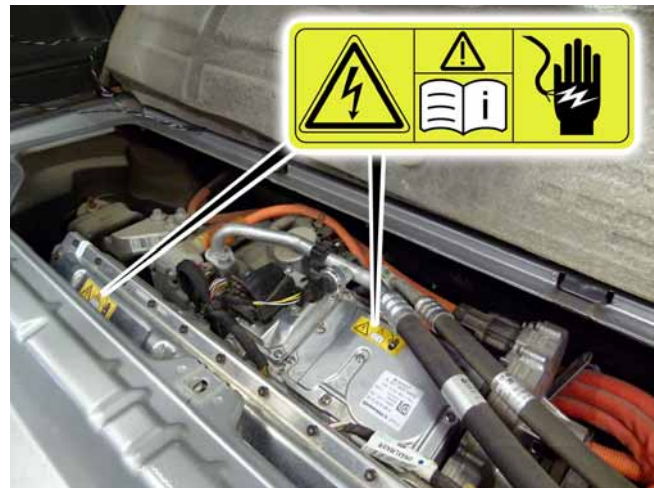

Engine compartment with high-voltage cables and warning labels

P00.00-4999-00

High-voltage charging plug



High-voltage charging plug  
US / Canada



A-pillar left / right

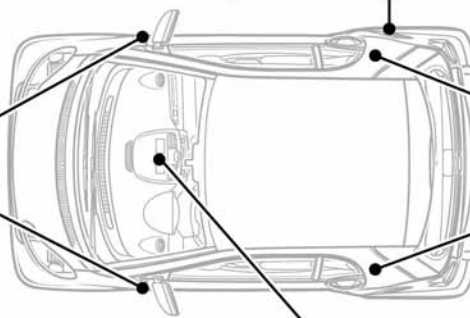

B-pillar left / right

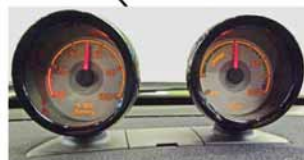

Display devices on the dashboard

# High-voltage disconnect

## Manual high-voltage disconnect

The high-voltage disconnect is placed on the lower side of the instrument panel on the left side in the direction of travel.

Procedure for manual high-voltage system shut-down:

- Switch off the ignition of the vehicle and pull out the key
- Pull the red plug (1) out off the mounting bracket
- Disconnect the 12 V battery (2) in the passenger-side footwell

Pulling the high-voltage disconnect interrupts the connection of the vehicle high-voltage system to the high-voltage battery. The high-voltage system is discharged in **5 seconds**.

The manual high-voltage disconnect **does not conduct high-voltage** and can be operated safely.

Even with the high-voltage disconnect removed the battery still is charged and carries high-voltage.

### Note

#### Automatic high-voltage disconnect

In the event of an accident, the high-voltage system can be shut off by the restraint system control unit or alternatively, by the high-voltage crash sensor control unit.

If the restraint system control unit triggers an activated occupant protection system (airbag, seat-belt tensioner etc.) in an accident, the pyrofuse in the control cable of the battery contactors is also triggered. The control cable of the high-voltage system is then physically disconnected.

In this case the high-voltage output remains **irreversibly** deactivated and can only be reactivated by service personnel.

The high-voltage crash sensor shuts off the high-voltage system under following conditions:

- Ignition switch is turned off, but the high-voltage system is active: in the event of a stationary crash during charging
- During driving operation: in the event of a vehicle rollover



P54.10-3918-00

High-voltage disconnect located in driver-side footwell



P54.10-3919-00

High-voltage disconnect

1 High-voltage disconnect plug



P54.10-3920-00

12 V battery in passenger-side footwell

2 Battery 12 V

# Electrical safety information

## General information on the high-voltage system

The high-voltage system consists of several components. The individual components are connected by high-voltage-carrying electrical cables. The high-voltage on-board electrical system is a fully insulated network. Neither the positive terminal nor the negative terminal are connected to the vehicle ground.

## Identification of high-voltage components and high-voltage cables

Every component of the high-voltage system installed in the vehicle is identified by a yellow warning label. All electrical cables conducting high-voltage are color-coded (in orange).

## Protective measures against the hazards of electrical current:

- All components that operate with high-voltage feature protection against accidental contact.
- All components that operate with high-voltage are marked with warning labels. High-voltage cables supplying the components are colored orange for identification.
- All-pole separation of the energy sources and storage units.
- Deactivation of the generator function and disabling of the DC/DC converter.
- Automatic shutdown in the event of short circuit (software and fuse) to avoid high-voltage cable overloads.
- Shutdown of the high-voltage system in an accident by triggering of the pyrofuse actuated by the restraint systems control unit (crash detection).
- Active discharging of the intermediate circuit capacitors to below a critical value.



Warning label for high-voltage components

P08.00-2008-00



Due to the high-voltage technology, electrical cables and components which operate under high-voltage are used in the vehicle. Accordingly, special care must be taken at all area of the vehicle which are linked to the high-voltage system e.g. parts in the engine compartment. Orange-coloured cables and their connectors conduct high-voltage and may not be damaged.

## To avoid injury from electric shock, observe the following instructions:

- **Deactivate the high-voltage circuit!**
- **Do not cut any high-voltage cables!**
- **Avoid cutting or deforming the bodywork with rescue equipment in the vicinity of cables and components carrying high-voltage!**
- **Avoid touching damaged orange cables and their damaged connectors!**
- **Avoid touching damaged components of the high-voltage drive system!**



# General safety informations

## Extricating occupants

Before using spreader and cutting tools to rescue occupants, the high-voltage system and the 12 V system must be disconnect to prevent unintentional deployment of the restraint systems.

The high-voltage battery is located below the floor, under a floor pan. To avoid damage to the high-voltage battery, the vehicle may only be jacked up and supported in the marked areas of the underfloor. A yellow warning label on both vehicle sills showing the jacking up areas.

## Vehicle fire

Basically a burning electric vehicle can be extinguished with any available extinguishing media. If possible, the high-voltage battery should be purged with water. By a permanent water flowing around, the high-voltage battery enclosure can be cooled (oceanic effect), for a controlled burning of the high-voltage battery and no further spread of fire.

Avoid having contact with leaking battery fluids. Battery fluids are irritating or corrosive. Do not inhale electrolyte vapors. Electrolyte can be absorbed using conventional binders.

## Moving and towing

It's allowed to remove electric vehicle from the immediate area of danger by means of towing for a short distance and at low speeds. However, voltage is generated with the drive axle being propelled. Therefore, electric powered vehicles should be transported on a flatbed truck in principle. If a flatbed truck is not available, the vehicle should be towed with the drive axle off the ground.



P00.60-2195-00

Warning label for jacking up areas



It can not be excluded that after a serious accident a danger of the high-voltage battery may exist also at a later stage. Always advise second responders (law enforcement, tow personal).

# General safety informations

---

## **Submerged or partially submerged vehicle**

Completely or partly submerged electric vehicles can be rescued the same way as conventional vehicles. Basically water does not increase the risk of an electric shock when touching the car body or the framework.

## **Vehicle at the charging station**

If the vehicle's on-board charger detects an error, charging will be stopped on the vehicle side. The activation status of the vehicle's high-voltage system is not reflected in the state of the charging station.

In the event of a stationary crash, the high-voltage system is to deactivate via the high-voltage disconnect. Pull the charging cable from the charging station or deactivate the power supply of the charging station.

# Information and copyright

---

## **Product Portfolio**

You can also find comprehensive information on our complete product portfolio in our Internet portal:  
Link: <http://aftersales.mercedes-benz.com>

## **Questions and suggestions**

If you have any questions or suggestions concerning this product, please write to us.  
Email: [customer.support@daimler.com](mailto:customer.support@daimler.com)  
Tel: +49 (0) 69-95 30 73 76

© 2013 by Daimler AG

This document, including all its parts, is protected by copyright. Any further processing or use requires the previous written consent of Daimler AG, Department GSP/OR, D-70546 Stuttgart. This applies in particular to reproduction, distribution, alteration, translation, microfilming and storage and/or processing in electronic systems, including databases and online services.

06/13

