



2014-2015 ALL-WHEEL
DRIVE DUAL MOTOR
MODEL S

EMERGENCY RESPONSE
GUIDE

This guide is intended only for use by trained and certified rescuers and first responders. It assumes that readers have a comprehensive understanding of how safety systems work and have completed the appropriate training and certification required to safely handle rescue situations. Therefore, this guide provides only the specific information required to understand and safely handle the fully electric Model S in an emergency situation. It describes how to identify Model S, and provides the locations and descriptions of its high voltage components, airbags, inflation cylinders, seat belt pre-tensioners, and high strength materials used in its body structure. This guide includes the high voltage disabling procedure and any safety considerations specific to Model S. Failure to follow recommended practices or procedures can result in serious injury or death.

The high voltage battery is the main energy source. Model S does not have a traditional gasoline or diesel engine and therefore does not have a fuel tank. The rear motor in dual motor Model S comes in two types: regular and high performance. The images in this guide might not match the vehicle you are working on.

IDENTIFYING MODEL S.....	1
BADGING.....	1
LARGE SCREEN.....	2
CHARGE PORT.....	2
HIGH VOLTAGE COMPONENTS	3
OVERVIEW OF HIGH VOLTAGE COMPONENTS.....	3
HIGH VOLTAGE BATTERY	4
DC-DC CONVERTER AND FRONT JUNCTION BOX.....	5
HIGH VOLTAGE CABLING.....	6
CHARGERS.....	7
FRONT DRIVE UNIT.....	8
REAR DRIVE UNIT.....	9
LOW VOLTAGE SYSTEM	10
12V BATTERY.....	10
DISABLING HIGH VOLTAGE.....	11
FIRST RESPONDER CUT LOOP - FRONT TRUNK.....	11
CUTTING THE FIRST RESPONDER LOOP - FRONT TRUNK	12
FIRST RESPONDER DISCONNECT POINT - REAR PILLAR.....	13
CUTTING THE FIRST RESPONDER DISCONNECT POINT - REAR PILLAR.....	14
STABILIZING MODEL S.....	15
AIRBAGS AND SUPPLEMENTARY RESTRAINT SYSTEM (SRS)	16
AIRBAGS.....	16
AIRBAG INFLATION CYLINDERS.....	16
SEAT BELT PRE-TENSIONERS	17
REINFORCEMENTS.....	18
NO-CUT ZONES.....	19
RESCUE OPERATIONS	20
FULLY OR PARTIALLY SUBMERGED VEHICLES	20

PUSHING ON THE FLOOR PAN.....	20
FIREFIGHTING	21
HIGH VOLTAGE BATTERY - FIRE DAMAGE	21
LIFTING MODEL S	22
OPENING MODEL S	23
USING THE KEY	23
OPENING DOORS.....	23
OPENING REAR DOORS WITH NO POWER.....	23
OPENING THE TRUNK.....	24
OPENING THE HOOD (FRONT TRUNK)	24
HIGH VOLTAGE LABELS	25
INDEX	26

BADGING

Dual motor Model S has four main badges to distinguish it.

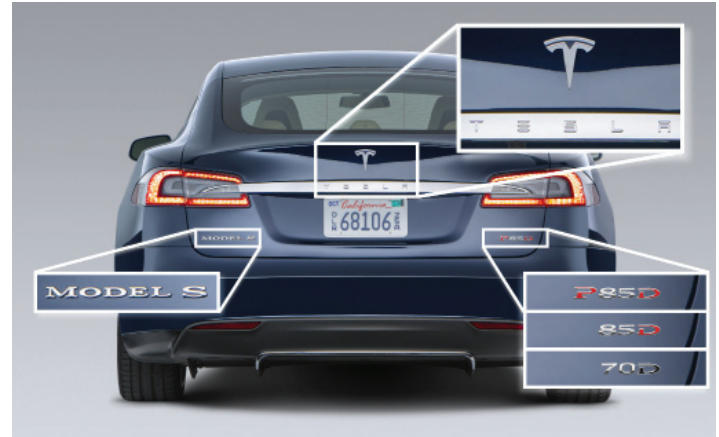
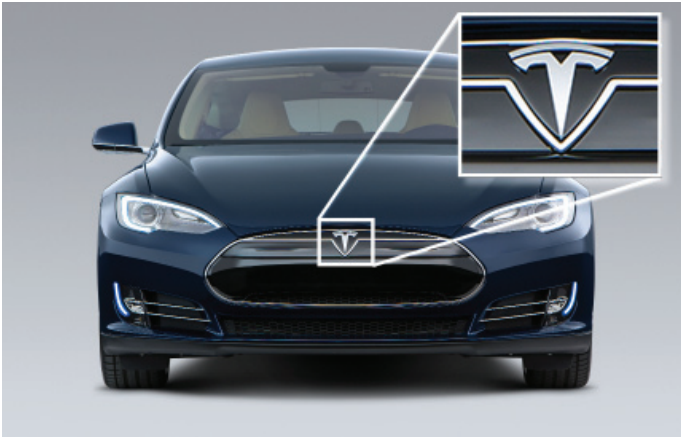

LARGE SCREEN

Model S has a large 17" touchscreen.



CHARGE PORT

Model S has a charge port that is integrated into the taillight on the rear left side fender.

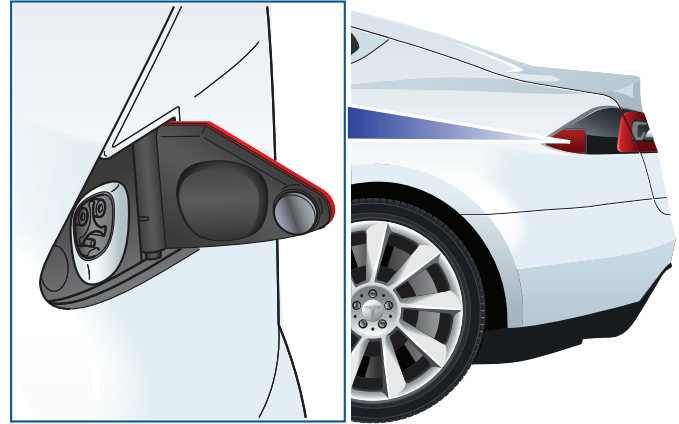

OVERVIEW OF HIGH VOLTAGE COMPONENTS

1. A/C compressor
2. Battery coolant heater
3. High voltage cabling (colored orange)
4. 10 kW on-board master charger
5. Front motor
6. DC-DC converter and front junction box
7. Cabin heater
8. High Voltage Battery
9. OPTIONAL: 10 kW on-board slave charger
10. Charge port
11. Rear motor/rear high performance motor

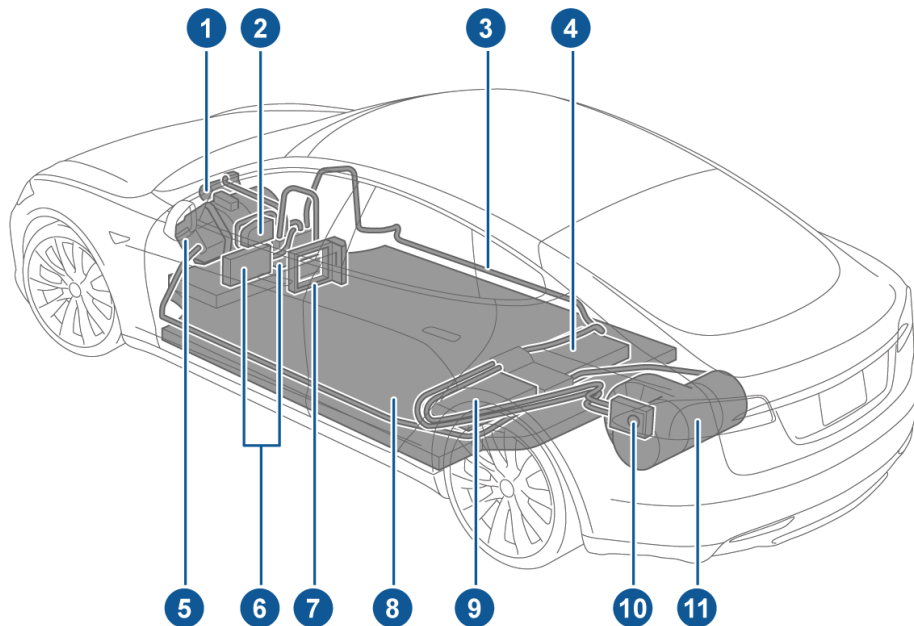

WARNING: After deactivation, the high voltage circuit requires two minutes to deplete.



WARNING: The SRS control unit has a backup power supply with a discharge time of approximately ten seconds.



WARNING: Regardless of the disabling procedure you use, ALWAYS ASSUME THAT ALL HIGH VOLTAGE COMPONENTS ARE ENERGIZED! Cutting, crushing or touching high voltage components can result in serious injury or death.

HIGH VOLTAGE BATTERY

Model S is equipped with a floor-mounted 400 volt lithium-ion high voltage battery. Never breach the high voltage battery when lifting from under the vehicle. When using rescue tools, pay special attention to ensure that you do not breach the floor pan.

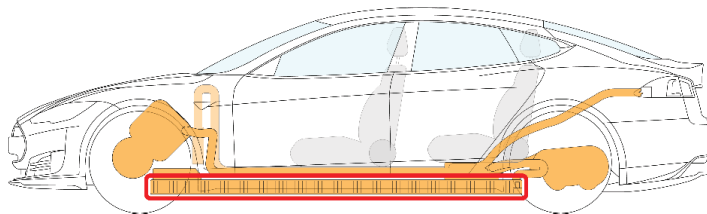
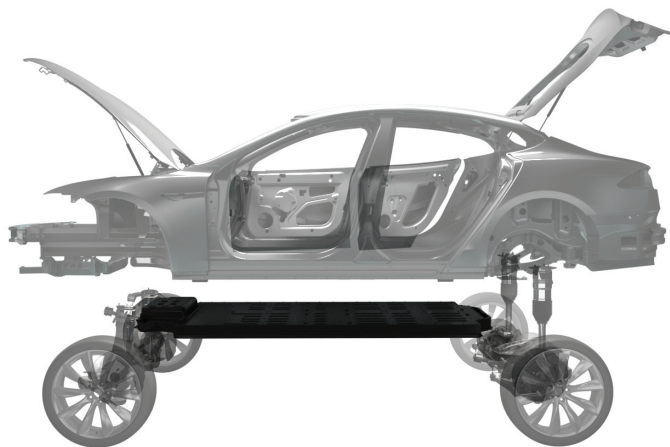

High voltage battery is located below the floor



WARNING: Regardless of the disabling procedure you use, ALWAYS ASSUME THAT ALL HIGH VOLTAGE COMPONENTS ARE ENERGIZED! Cutting, crushing or touching high voltage components can result in serious injury or death.



DC-DC CONVERTER AND FRONT JUNCTION BOX

High voltage is present at the DC-DC converter and front junction box, located behind the front motor. The DC-DC converter transforms the high voltage current from the 400 volt battery to low voltage to charge the Model S 12 volt battery. The front junction box provides power to various components, such as the Battery heater, the air conditioning compressor and the cabin heater. Use caution when cutting in this area during a dash lift (dash roll) procedure—use work-around techniques, if necessary.

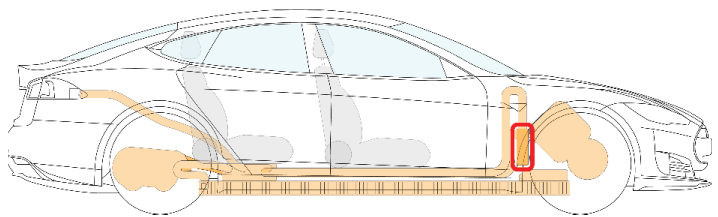
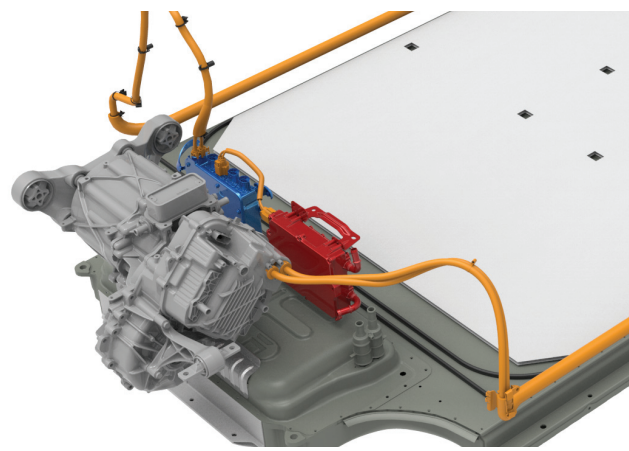

DC-DC converter and front junction box are located behind the front trunk, near the center of the vehicle



WARNING: Regardless of the disabling procedure you use, ALWAYS ASSUME THAT ALL HIGH VOLTAGE COMPONENTS ARE ENERGIZED! Cutting, crushing or touching high voltage components can result in serious injury or death.

HIGH VOLTAGE CABLING

High voltage cabling is highlighted in dark orange in the following illustration.

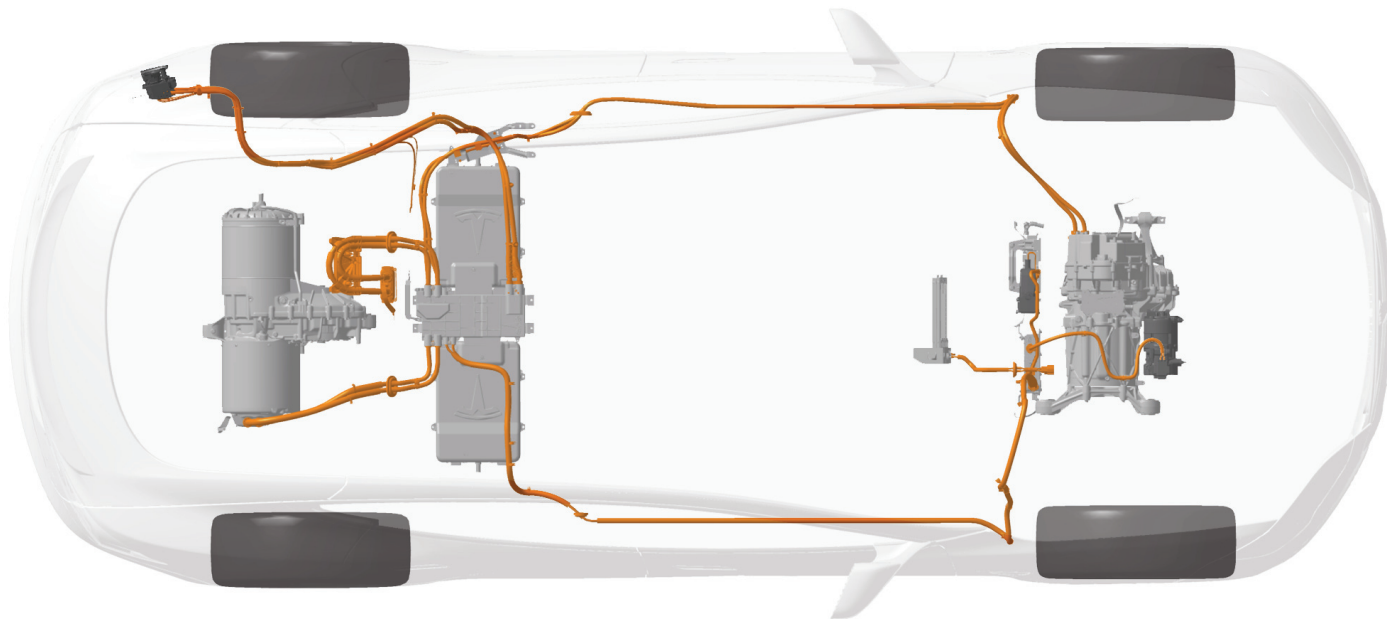

High voltage cabling is routed under the rear seats and inside the rocker panel on the left and right side front



WARNING: Regardless of the disabling procedure you use, ALWAYS ASSUME THAT ALL HIGH VOLTAGE COMPONENTS ARE ENERGIZED! Cutting, crushing or touching high voltage components can result in serious injury or death.

CHARGERS

Model S has one (standard) or two (optional) chargers under the rear seat. These chargers convert the AC current from a charging station to DC for charging the high voltage battery. The high voltage junction box, located between the chargers, routes any surplus energy from regenerative braking back to the battery.

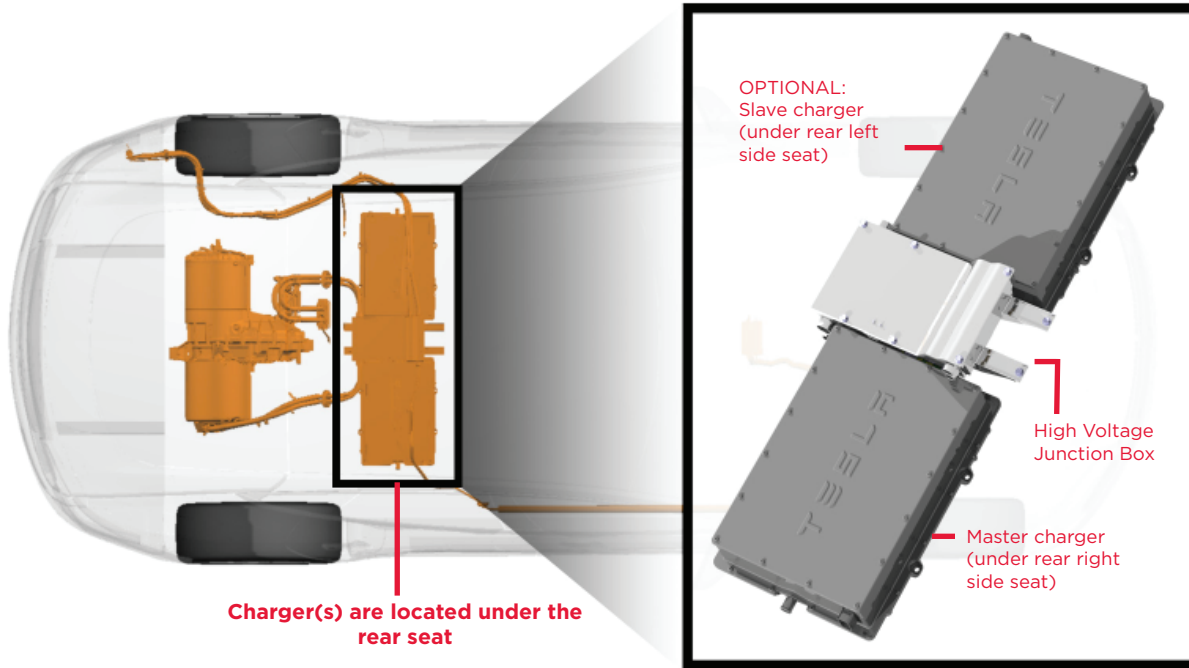

WARNING: Regardless of the disabling procedure you use, ALWAYS ASSUME THAT ALL HIGH VOLTAGE COMPONENTS ARE ENERGIZED! Cutting, crushing or touching high voltage components can result in serious injury or death.



FRONT DRIVE UNIT

The front drive unit is located between the front wheels in front of the dash panel of the Model S. It converts the DC current from the high voltage battery into the 3-phase AC current that the electric motor uses to power the front wheels.

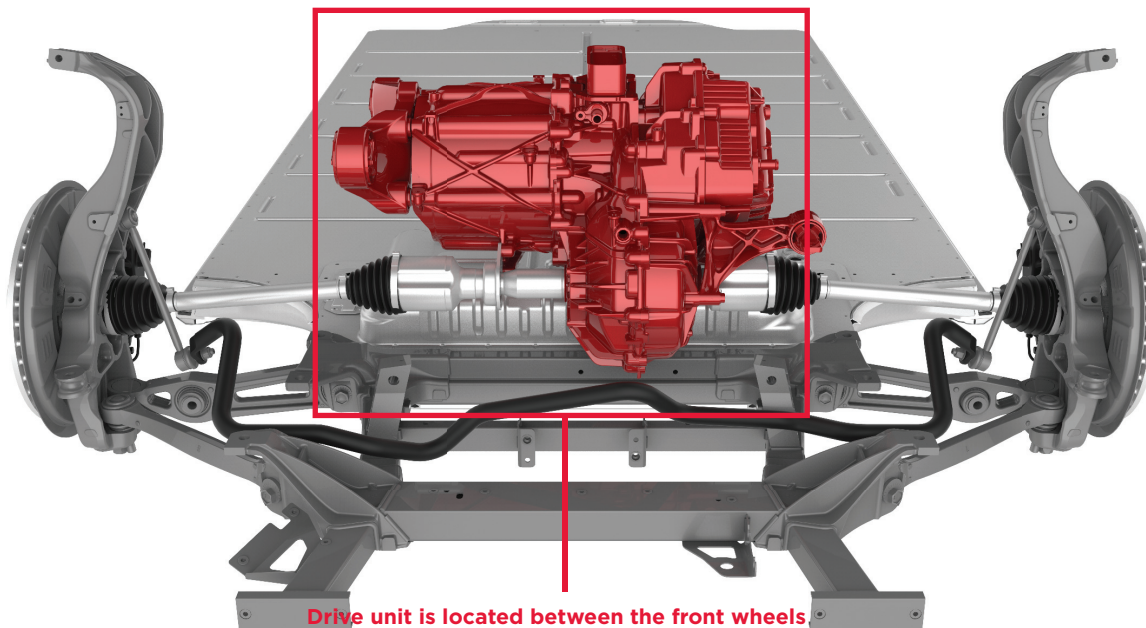

WARNING: Regardless of the disabling procedure you use, ALWAYS ASSUME THAT ALL HIGH VOLTAGE COMPONENTS ARE ENERGIZED! Cutting, crushing or touching high voltage components can result in serious injury or death.

REAR DRIVE UNIT

The rear drive unit is located between the rear wheels under the floor pan of the Model S (high performance drive unit shown below). It converts the DC current from the high voltage battery into the 3-phase AC current that the electric motor uses to power the rear wheels.

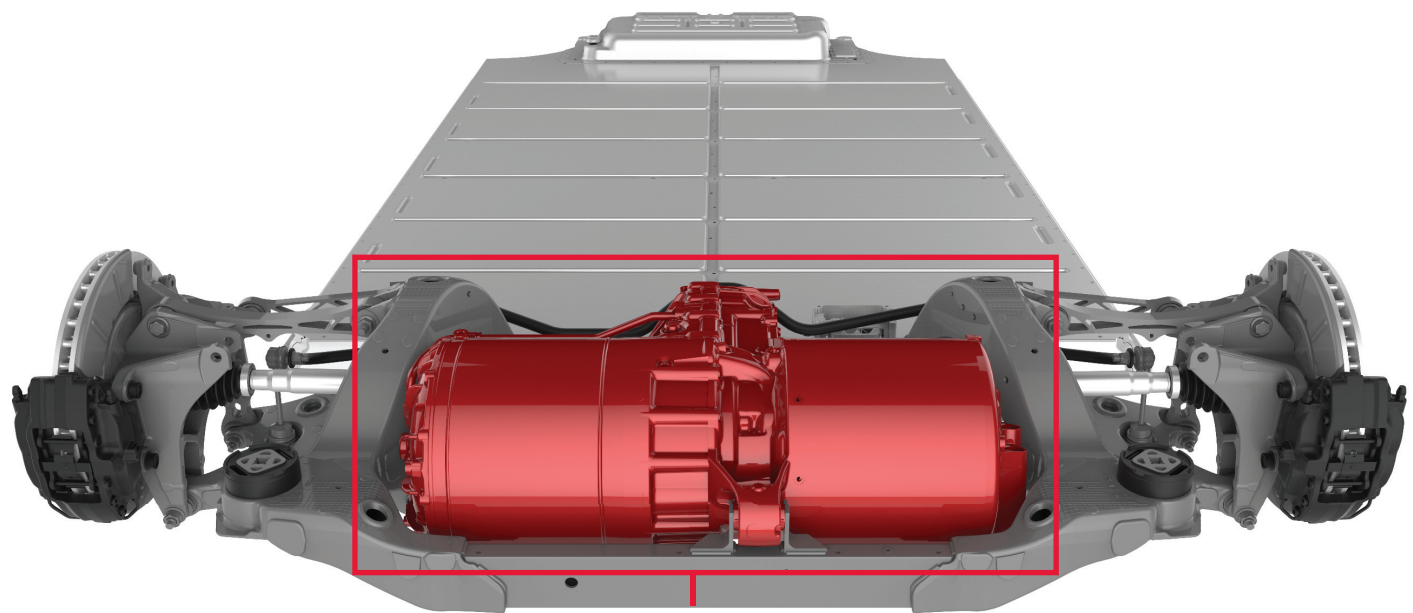

Drive unit is located between the rear wheels



WARNING: Regardless of the disabling procedure you use, ALWAYS ASSUME THAT ALL HIGH VOLTAGE COMPONENTS ARE ENERGIZED! Cutting, crushing or touching high voltage components can result in serious injury or death.

12V BATTERY

In addition to the high voltage system, Model S has a low voltage system, powered by a traditional 12 volt battery. The low voltage system operates the same electrical components found in conventional vehicles, including the supplementary restraint system (SRS), airbags, ignition, touchscreen, and interior and exterior lights.

The low voltage system interacts with the high voltage system. The DC-DC converter supplies the 12V battery with power to support low voltage functions, and the 12V battery supplies power to the high voltage contacts to allow power to flow out of the high voltage battery.

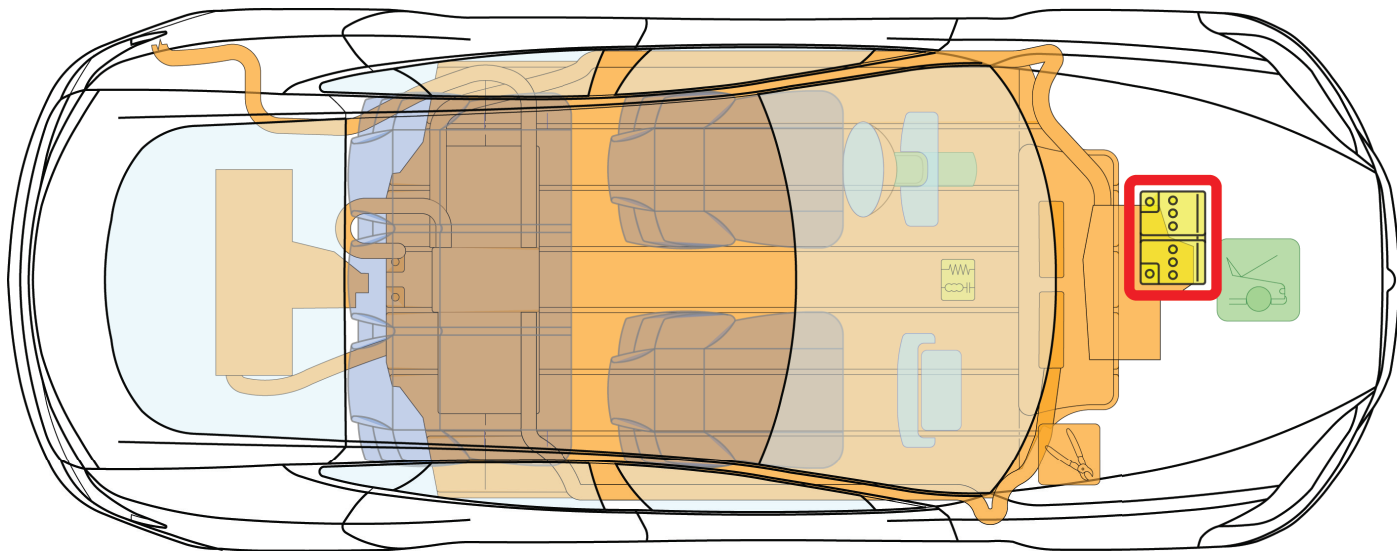

12V battery is located under the hood and the plastic access panel



WARNING: Regardless of the disabling procedure you use, ALWAYS ASSUME THAT ALL HIGH VOLTAGE COMPONENTS ARE ENERGIZED! Cutting, crushing or touching high voltage components can result in serious injury or death.

FIRST RESPONDER CUT LOOP - FRONT TRUNK

The front trunk first responder cut loop consists of low voltage wires. Cutting this loop shuts down the high voltage system and disables the SRS and airbag components. See cut instructions on page 11.

NOTE: When cutting the loop, double cut to remove an entire section. This eliminates the risk of the cut wires accidentally reconnecting.

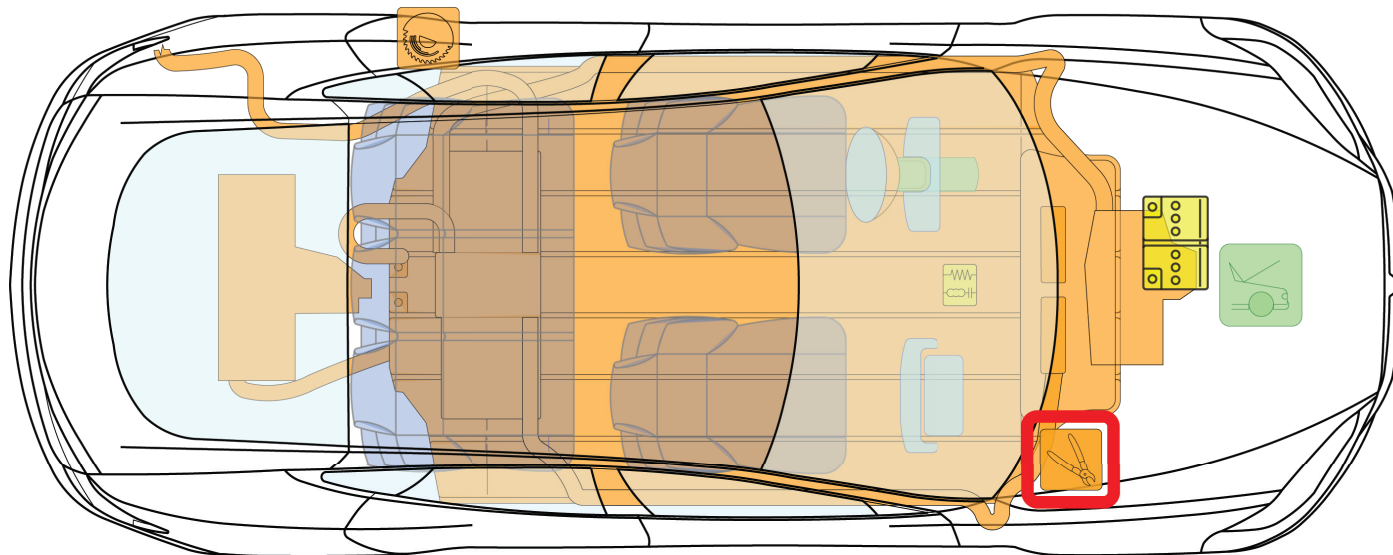

The front trunk cut loop is located on the right side, under the hood and the plastic access panel



WARNING: Regardless of the disabling procedure you use, ALWAYS ASSUME THAT ALL HIGH VOLTAGE COMPONENTS ARE ENERGIZED! Cutting, crushing or touching high voltage components can result in serious injury or death.

CUTTING THE FIRST RESPONDER CUT LOOP - FRONT TRUNK

STEP 1: Open the hood (also known as the Front Trunk). See page 23 for details.

The cut loop is located on the right side. Its label protrudes from under the plastic access panel.



STEP 2: Remove the access panel by pulling its rear edge upward to release the five clips that hold it in place. Maneuver it toward the windshield to remove.

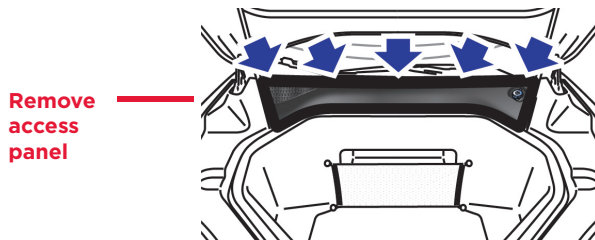

STEP 3: **DOUBLE CUT** the loop to remove an entire section.

Removing an entire section of the cut loop eliminates the risk of the wires accidentally touching (reconnecting).



WARNING: Regardless of the disabling procedure you use, ALWAYS ASSUME THAT ALL HIGH VOLTAGE COMPONENTS ARE ENERGIZED! Cutting, crushing or touching high voltage components can result in serious injury or death.

FIRST RESPONDER DISCONNECT POINT - REAR PILLAR

If the front trunk cut loop is inaccessible, the rear pillar disconnect point can shut down the high voltage system and disable the SRS and airbag components in the same manner as the front trunk cut loop. See cut instructions on page 14.

NOTE: Only one point needs to be disconnected, not both.

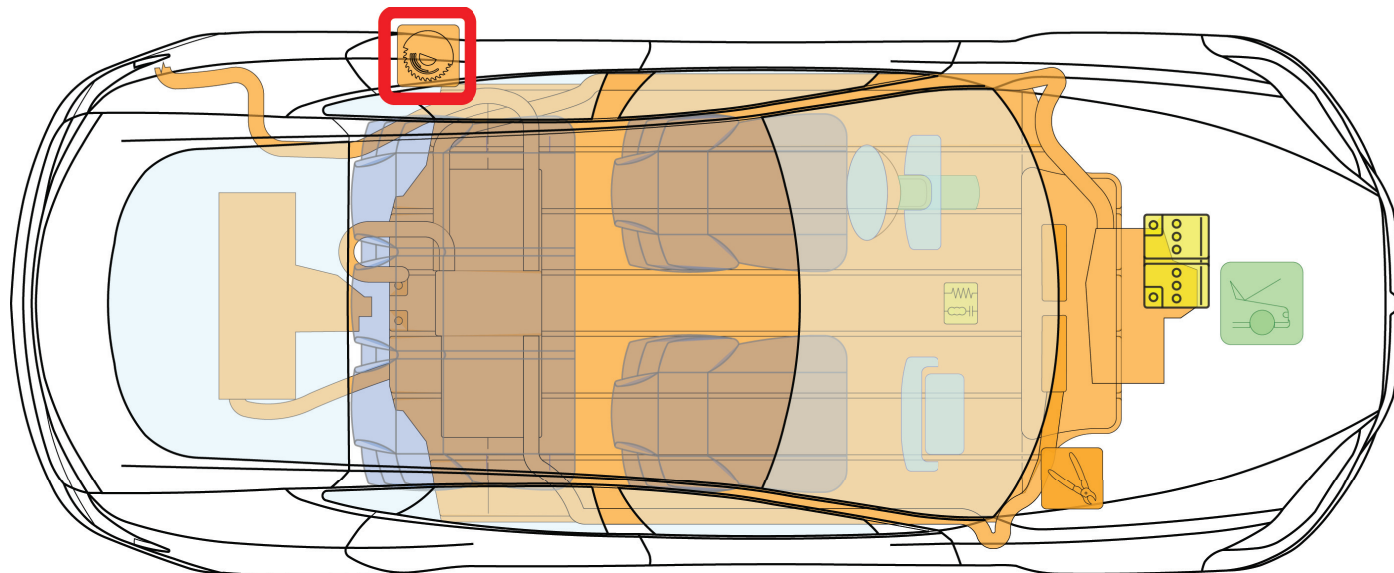

WARNING: Regardless of the disabling procedure you use, ALWAYS ASSUME THAT ALL HIGH VOLTAGE COMPONENTS ARE ENERGIZED! Cutting, crushing or touching high voltage components can result in serious injury or death.

CUTTING THE FIRST RESPONDER DISCONNECT POINT - REAR PILLAR

STEP 1: Open the rear passenger door closest to the charge port. The disconnect point is located under the body panel on the outside of the seat. The label indicates where to cut into the body panel.



STEP 2: Use a 12" circular saw to cut 6 in (152 mm) through the label and into the pillar.



Cut loop label



WARNING: Regardless of the disabling procedure you use, ALWAYS ASSUME THAT ALL HIGH VOLTAGE COMPONENTS ARE ENERGIZED! Cutting, crushing or touching high voltage components can result in serious injury or death.

STABILIZING MODEL S

CHOCK ALL FOUR WHEELS

Drivers can choose a setting that determines whether or not Model S will “creep” when a driving gear is selected. If this setting is off, Model S does not move unless the accelerator is pressed, even if shifted into Drive or Reverse. However, never assume that Model S will not move. Always chock the wheels.



SHIFT INTO PARK

Model S is silent so never assume it is powered off. Pressing the accelerator pedal even slightly can cause Model S to move quickly if the currently active gear is Drive or Reverse. To ensure that the parking brake is engaged, press the button on the end of the gear selector to shift into Park. Whenever Model S is in Park, the parking brake is automatically engaged so that the vehicle will not move if the accelerator pedal is pressed.



WARNING: Regardless of the disabling procedure you use, ALWAYS ASSUME THAT ALL HIGH VOLTAGE COMPONENTS ARE ENERGIZED! Cutting, crushing or touching high voltage components can result in serious injury or death.

AIRBAGS

Model S is equipped with six airbags (eight in North America). Responders should de-energize the airbags by cutting the First Responder Cut Loop (see page 11) or Disconnect Point (see page 13). Airbags are shown below in blue.

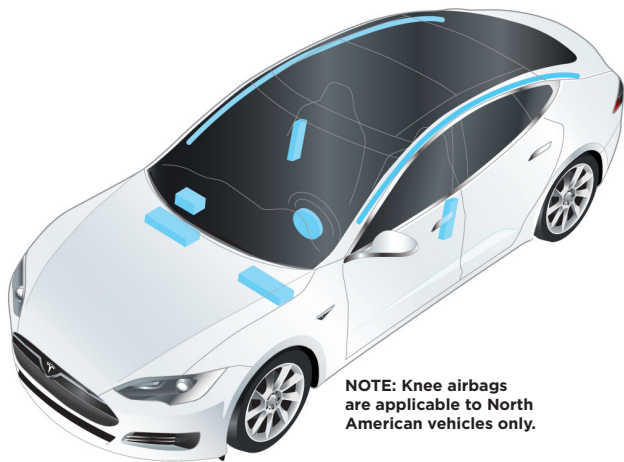

NOTE: Knee airbags are applicable to North American vehicles only.

AIRBAG INFLATION CYLINDERS

Airbag (stored gas) inflation cylinders are located toward the rear of the vehicle, as shown below in red.

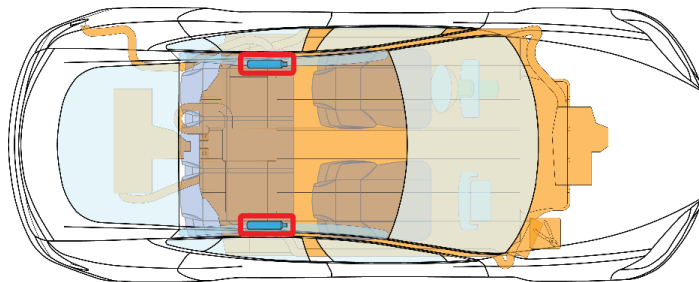

Airbag inflation cylinders are located toward the rear



WARNING: Regardless of the disabling procedure you use, ALWAYS ASSUME THAT ALL HIGH VOLTAGE COMPONENTS ARE ENERGIZED! Cutting, crushing or touching high voltage components can result in serious injury or death.

SEAT BELT PRE-TENSIONERS

Seat belt pre-tensioners are located by the B-pillars, as shown below in red.

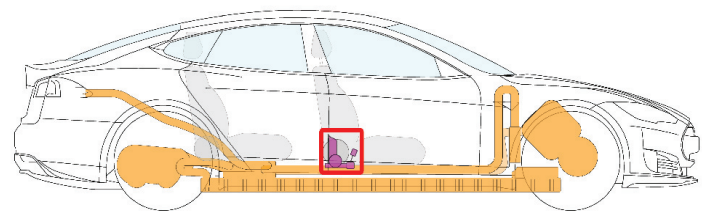
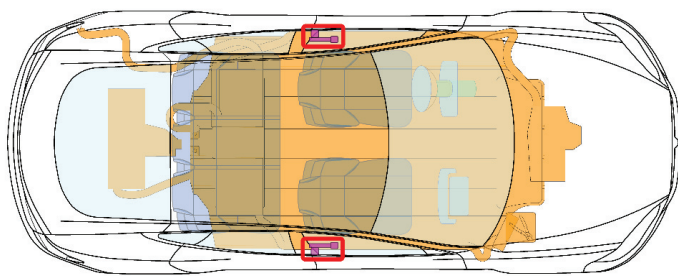

Seat belt pre-tensioners are located by the B-pillars



WARNING: Regardless of the disabling procedure you use, ALWAYS ASSUME THAT ALL HIGH VOLTAGE COMPONENTS ARE ENERGIZED! Cutting, crushing or touching high voltage components can result in serious injury or death.

LOCATION OF REINFORCEMENTS AND HIGH STRENGTH STEEL

Model S is reinforced to protect occupants in a collision. Reinforcements are shown below in green (high strength steel) and blue (extruded aluminum).

Depending on the tools used, high strength steel can be challenging or impossible to cut. If necessary, use workaround techniques.

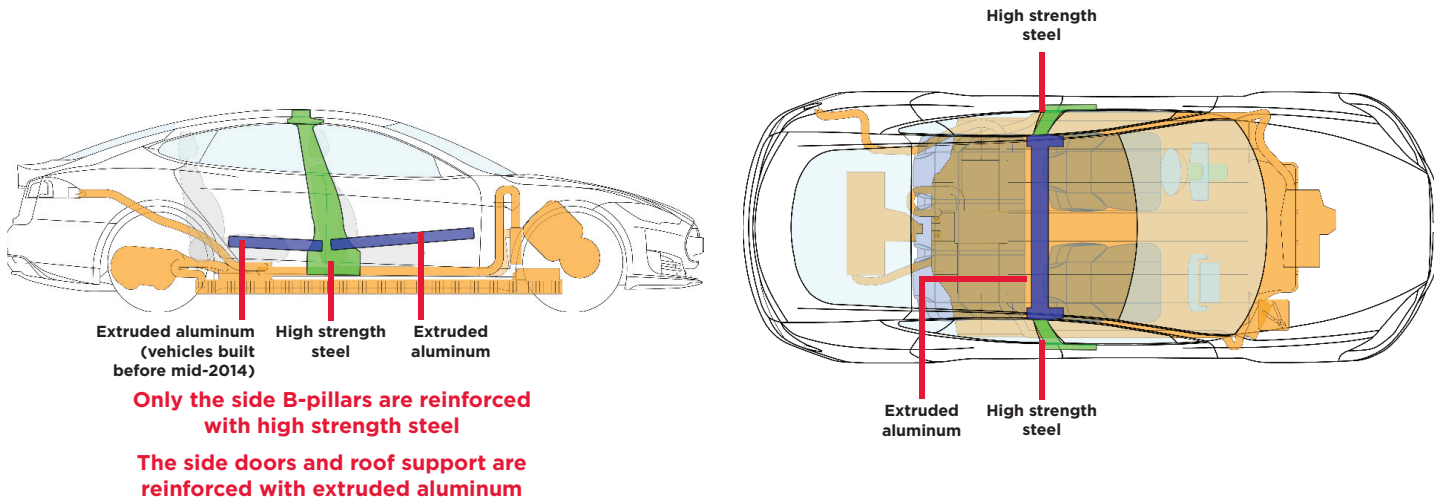

WARNING: Always use appropriate tools (such as a hydraulic cutter), and always wear appropriate personal protective equipment (PPE) when cutting Model S. Failure to follow these instructions can result in serious injury or death.



WARNING: Regardless of the disabling procedure you use, ALWAYS ASSUME THAT ALL HIGH VOLTAGE COMPONENTS ARE ENERGIZED! Cutting, crushing or touching high voltage components can result in serious injury or death.

NO-CUT ZONES

Model S has areas that are defined as “no-cut zones” due to high voltage, gas struts, and SRS or airbag hazards. Never cut or crush these areas—doing so can result in serious injury or death.

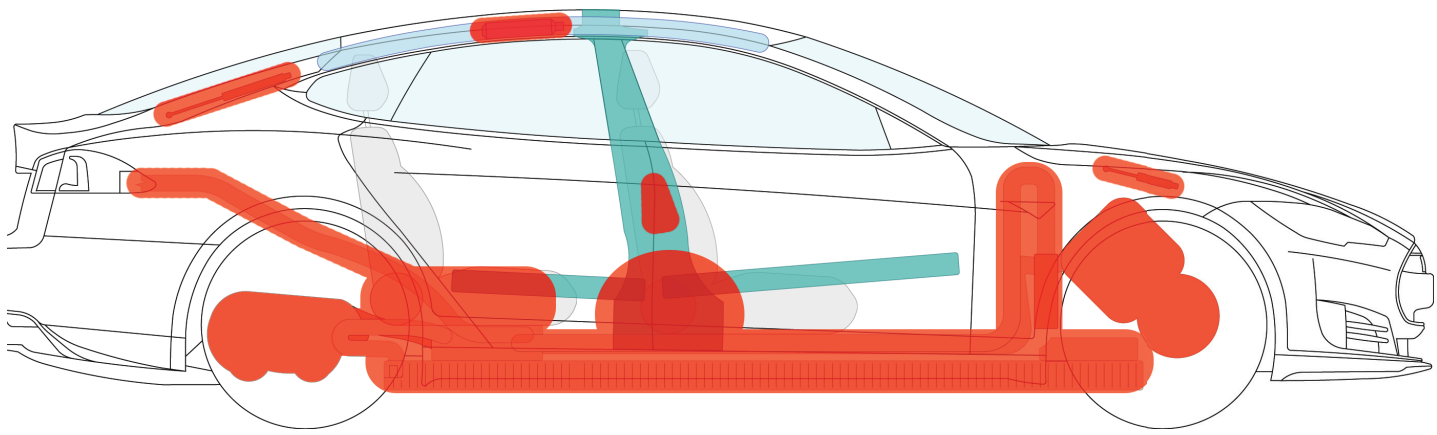

Do not cut through areas shown in red



WARNING: Always use appropriate tools (such as a hydraulic cutter), and always wear appropriate personal protective equipment (PPE) when cutting Model S. Failure to follow these instructions can result in serious injury or death.



WARNING: Regardless of the disabling procedure you use, ALWAYS ASSUME THAT ALL HIGH VOLTAGE COMPONENTS ARE ENERGIZED! Cutting, crushing or touching high voltage components can result in serious injury or death.



FULLY OR PARTIALLY SUBMERGED VEHICLES

Treat a submerged Model S like any other vehicle. The body of the vehicle does not present a risk of shock in water. However, as a precautionary measure, handle any submerged vehicle while wearing the appropriate personal protective equipment (PPE). Remove the vehicle from the water and continue with normal high voltage disabling.



PUSHING ON THE FLOOR PAN

The high voltage battery is located below the floor pan. Never push down on the floor pan from inside Model S. Doing so can breach the high voltage battery, which can cause serious injury or death.

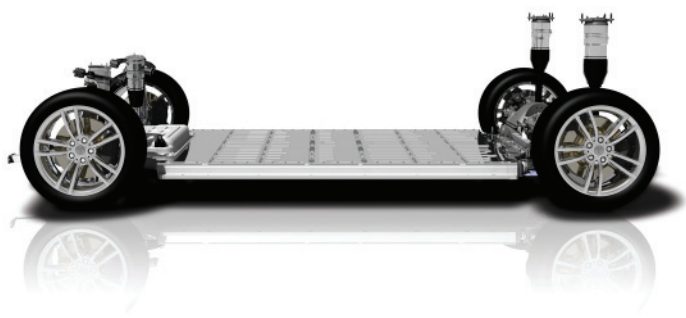

WARNING: Failure to handle a submerged vehicle without appropriate personal protective equipment (PPE) can result in serious injury or death.



WARNING: Regardless of the disabling procedure you use, ALWAYS ASSUME THAT ALL HIGH VOLTAGE COMPONENTS ARE ENERGIZED! Cutting, crushing or touching high voltage components can result in serious injury or death.

FIREFIGHTING

Extinguish small fires, that do not involve the high voltage battery, using a CO₂ or ABC extinguisher.

During overhaul, do not make contact with any high voltage component. Always use insulated tools for overhaul.

Stored gas inflation cylinders, gas struts, and other components can result in a boiling liquid expanding vapor explosion (BLEVE) in extreme temperatures. Perform an adequate “knock down” on the fire before entering the incident’s “hot zone.”

If the high voltage battery becomes involved in fire or is bent, twisted, damaged, or breached in any way, or if you suspect that the battery is heating, use large amounts of water to cool the battery. DO NOT extinguish fire with a small amount of water. Always establish or request an additional water supply.

Battery fires can take up to 24 hours to fully extinguish. Consider allowing the vehicle to burn while protecting exposures.

Use a thermal imaging camera to ensure the high voltage battery is completely cooled before leaving the incident. If a thermal imaging camera is not available, you must monitor the battery for re-ignition. Smoke indicates that the battery is still heating. Do not release the vehicle to second responders until there has been no sign of smoke from the battery for at least one hour.

Always advise second responders (law enforcement, tow personnel) that there is a risk of the battery re-igniting. After a Model S has been involved in a submersion, fire, or a collision that has compromised the high voltage battery, always store it in an open area with no exposures within 50 feet.



WARNING: When fire is involved, consider the entire vehicle energized and DO NOT TOUCH any part of the vehicle. Always wear full PPE, including SCBA.



WARNING: Regardless of the disabling procedure you use, ALWAYS ASSUME THAT ALL HIGH VOLTAGE COMPONENTS ARE ENERGIZED! Cutting, crushing or touching high voltage components can result in serious injury or death.

HIGH VOLTAGE BATTERY - FIRE DAMAGE

A burning or heating battery releases toxic vapors. These vapors include sulfuric acid, oxides of carbon, nickel, aluminum, lithium, copper, and cobalt. Responders should wear full personal protective equipment (PPE), including self-contained breathing apparatus (SCBA), and take appropriate measures to protect civilians downwind from the incident. Use fog streams or positive pressure ventilation (PPV) fans to direct vapors.

The high voltage battery consists of lithium-ion cells. These are considered dry cell batteries. If damaged, only a small amount of battery fluid can leak. Lithium-ion battery fluid is clear in color.

The high voltage battery, the drive unit, the charge controllers, and the DC-DC converter are liquid cooled with typical glycol-based coolant. If damaged, blue fluid can leak out of the battery.

A damaged high voltage battery can cause rapid heating of the battery cells. If you notice smoke coming from the battery area, assume the battery is heating and take appropriate action as described under the heading “FIREFIGHTING” on this page.

LIFT AREAS

The high voltage battery is located below the floor, under a floor pan. A large section of the undercarriage houses this battery. When lifting Model S, do not push on the high voltage battery. When lifting or jacking, use only the designated lifting areas.



Appropriate lifting locations

Yellow

Safe stabilization points for a side-resting Model S

Orange

High voltage battery. **DO NOT USE THIS AREA TO LIFT OR STABILIZE MODEL S!**

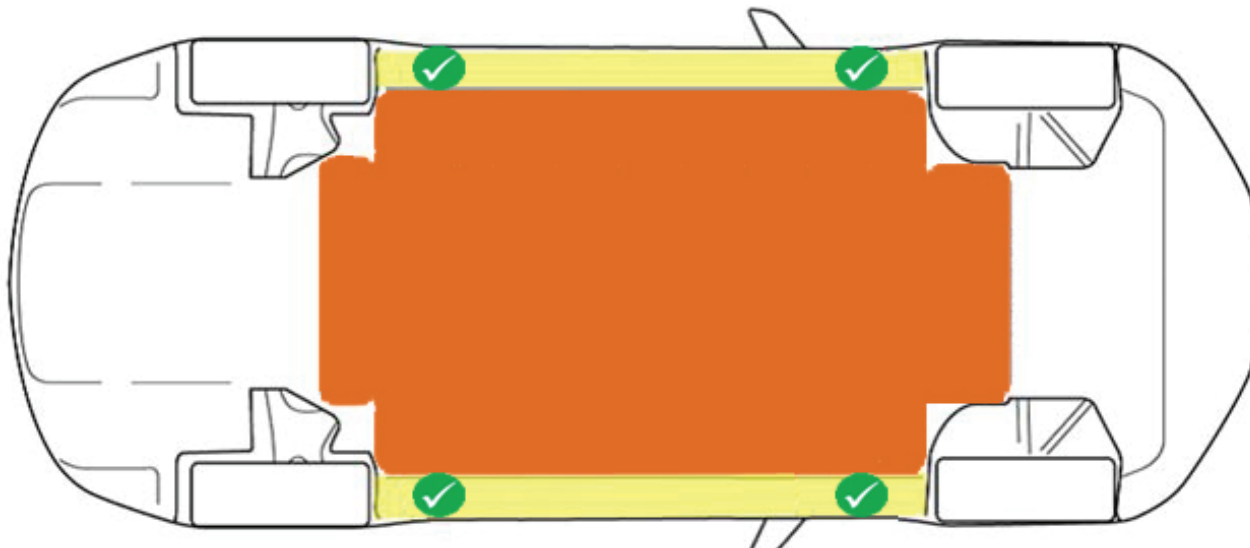

WARNING: Regardless of the disabling procedure you use, ALWAYS ASSUME THAT ALL HIGH VOLTAGE COMPONENTS ARE ENERGIZED! Cutting, crushing or touching high voltage components can result in serious injury or death.

USING THE KEY

Use the key's buttons as shown below.

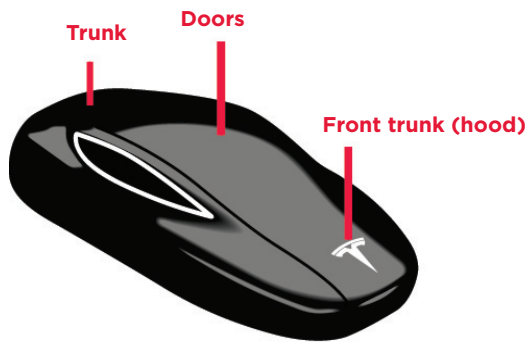

OPENING DOORS

Model S has unique door handles. Under normal conditions, when you press a handle, it extends* to allow you to open the door.

If door handles do not function, open the door manually by reaching inside the window and using the interior handle.

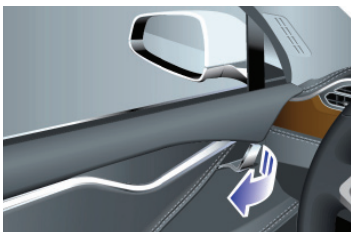
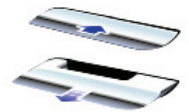

OPENING REAR DOORS WITH NO POWER

Open rear doors from inside by folding back the edge of the carpet below the rear seats to access the mechanical release cable. Pull the mechanical release cable toward the center.

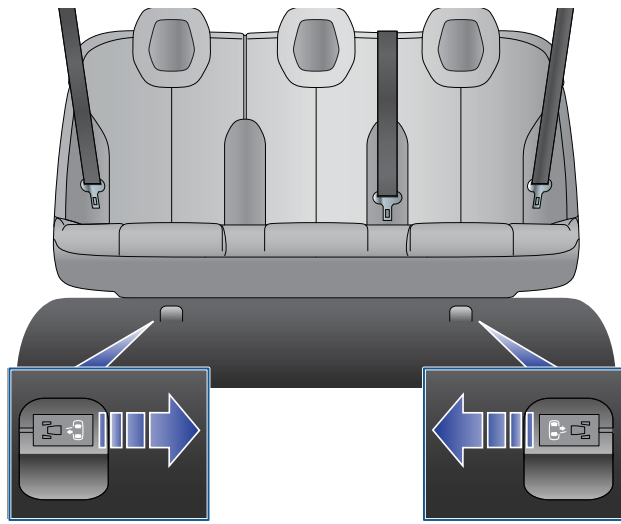

*NOTE: When an airbag inflates, Model S unlocks all doors, unlocks the trunk, and extends all door handles.

OPENING THE TRUNK

Use one of the following methods:

- Press the switch located under the handle.
- Touch Trunk on the touchscreen CONTROLS window.
- Double-click the trunk button on the key.

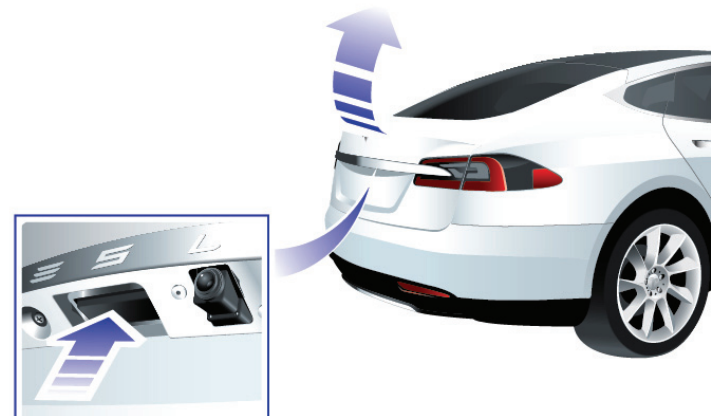
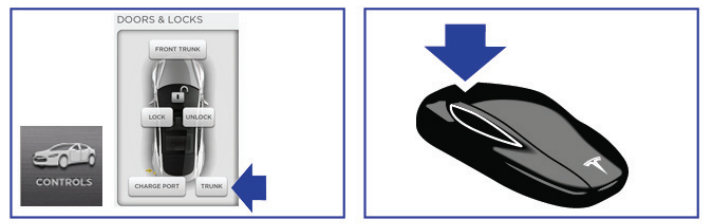

OPENING THE HOOD (FRONT TRUNK)

Model S does not have a traditional engine. Therefore, the area that would normally house the engine is used as additional storage space. Tesla calls this area the “Front Trunk” or “Frunk”.

To open the hood electronically, use one of the following methods:

- Touch Front Trunk on the touchscreen.
- Double-click the Front Trunk (hood) button on the key.

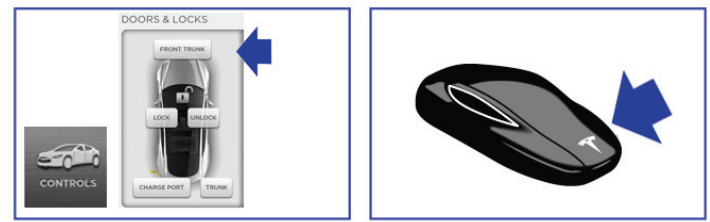

To open the hood manually, perform the following steps:



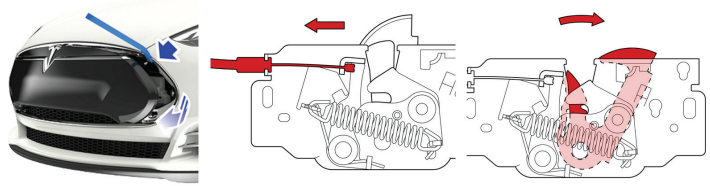





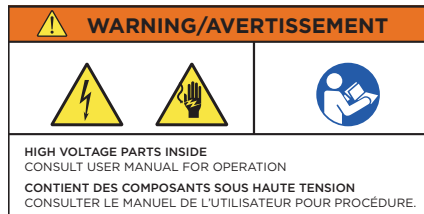

1. Pry the nose cone toward you using a plastic pry tool in the top right corner.
NOTE: A cable is connected to the rear of the nose cone.
2. Pull the primary release lever under the front middle of the hood to the left.
3. Push the secondary release lever under the front middle of the hood to the right and push up on the hood to open it.



HIGH VOLTAGE LABELS

Vehicle labels associated with high voltage components are shown below. These are examples only. Depending on the region, these labels may be translated into other languages.



 DANGER	
  	    
<p>HIGH VOLTAGE COMPONENTS KEEP OUT OF REACH OF CHILDREN</p> <ul style="list-style-type: none"> NEVER ATTEMPT TO REMOVE, DISASSEMBLE, OR MODIFY THIS UNIT OR USE IT FOR OTHER THAN ITS INTENDED PURPOSE. (PLEASE HAVE YOUR TESLA SERVICE CENTER OR A QUALIFIED TECHNICIAN HANDLE THE BATTERY.) DO NOT DISPOSE OF THIS UNIT. PLEASE CONTACT YOUR TESLA SERVICE CENTER FOR RECYCLING OR DISPOSAL OF THE BATTERY UNIT. DO NOT SUBJECT THIS UNIT TO PHYSICAL IMPACT THAT MAY CAUSE DAMAGE. KEEP THIS UNIT AWAY FROM FIRE. TRANSPORT THIS UNIT IN ACCORDANCE WITH ALL APPLICABLE LAWS. <p>FAILURE TO OBSERVE THE ABOVE MAY RESULT IN ELECTRICAL SHOCK, FIRE, OR SERIOUS INJURY.</p>	<p>TO QUALIFIED ELECTRIC VEHICLE TECHNICIANS BE SURE TO READ THE SERVICE MANUAL WHEN SERVICING OR REPLACING THIS UNIT.</p> <p>TO HAULERS AND DISMANTLERS PLEASE CONSULT WITH YOUR LOCAL TESLA SERVICE CENTER WHEN HAULING OR DISMANTLING THIS UNIT.</p> <p>HIGH VOLTAGE BATTERY RECYCLING INFORMATION PLEASE CONTACT YOUR LOCAL TESLA SERVICE CENTER FOR RECYCLING OR DISPOSAL OF THIS BATTERY UNIT.</p>
<p>COMPOSANTS HAUTE TENSION TENIR HORS DE PORTEE DES ENFANTS</p> <ul style="list-style-type: none"> NE TENTEZ JAMAIS D'ENLEVER, DE DÉMONTÉR OU DE MODIFIER CETTE BATTERIE, OU DE L'UTILISER POUR TOUT AUTRE USAGE QUE SON UTILISATION PRÉVUE. (TOUTE OPÉRATION SUR LA BATTERIE DOIT ÊTRE RÉALISÉE PAR UN CENTRE DE SERVICES TESLA OU UN TECHNICIEN QUALIFIÉ.) NE PAS JETER. CONTACTEZ VOTRE CENTRE DE SERVICES TESLA EN VUE DU RECYCLAGE DE CETTE BATTERIE OU DE SON ÉLIMINATION. NE PAS SOUMETTRE CETTE BATTERIE À TOUT CHOC OU CONTACT SUSCEPTIBLE DE L'ENDOMMAGER. TENIR ÉLOIGNÉ DE TOUTE FLAMME. LE TRANSPORT DE CETTE BATTERIE DOIT SE CONFORMER À TOUTE RÉGLEMENTATION APPLICABLE. <p>TOUT MANQUEMENT AU RESPECT DES CONSIGNES CI-DESSUS PEUT EXPOSER À DES RISQUES DE CHOC ÉLECTRIQUE, D'INCENDIE OU DE BLESSURE GRAVE.</p>	<p>À L'ATTENTION DES TECHNICIENS QUALIFIÉS VÉHICULES ÉLECTRIQUES SE REPORTER AU MANUEL D'ENTRETIEN LORS DE TOUTE OPÉRATION DE MAINTENANCE OU DE REMPLACEMENT DE CETTE BATTERIE.</p> <p>À L'ATTENTION DES TRANSPORTEURS ET DÉMANTELEURS VEUILLEZ CONTACTER LE CENTRE DE SERVICES TESLA LOCAL POUR TOUTE OPÉRATION DE TRANSPORT OU DE DÉMANTELEMENT DE CETTE BATTERIE.</p> <p>INFORMATIONS CONCERNANT LE RECYCLAGE DES BATTERIES HAUTE TENSION VEUILLEZ CONTACTER LE CENTRE DE SERVICES TESLA POUR TOUTE OPÉRATION DE RECYCLAGE OU D'ÉLIMINATION DE CETTE BATTERIE.</p> <p style="text-align: right; font-size: small;">1015713-00-A</p>
<p>For Service and Recycling in US: 1-877-79TESLA (1-877-798-3752)</p> <p>For Global Tesla Service Contact: http://www.teslamotors.com/about/contact</p>	
	

 **WARNING:** Regardless of the disabling procedure you use, ALWAYS ASSUME THAT ALL HIGH VOLTAGE COMPONENTS ARE ENERGIZED! Cutting, crushing or touching high voltage components can result in serious injury or death.

A

aluminum, extruded 18
airbags 16

B

badging 1
battery
 12V 10
 fires 21
 fluid 21
 high voltage 4
body components 18

C

cablings, high voltage 6
charge controllers, high voltage 7
charge port 2
cut loop for first responders 11

D

dash lift caution 5
DC-DC converter 5
disconnect point for first responders 13
door, opening 23
drive inverter, front 8
drive inverter, rear 9

F

fires 21
fluids 21

H

high voltage components
 battery 4
 battery fires 21
 cabling 6
 charge controllers 7
 DC-DC converter 5
 drive inverter, front 8
 drive inverter, rear 9
 junction box, front 5
 junction box, rear 7
 labels 25
 overview of 3
hood, opening 24

I

identifying Model S
 badging 1
 charge port 2
 large screen 2
instrument panel 2

J

jacking Model S 22
junction box, front 5
junction box, rear 7

K

key, using 23

L

labels, high voltage 25
lifting Model S 22
lithium-ion cells 21
locking, using key 23
low voltage system 10

P

Park gear 15
pre-tensioners, seat belt 17

R

reinforcements, location of 18
rescue operations
 firefighting 21
 floor pan 20
 submerged vehicles 20

S

seat belt pre-tensioners 17
second responders 21
side-resting vehicles 22
smoke 21
stabilization points (jacking) 22
stabilizing Model S 15
steel, high strength 18
submerged vehicles 20

T

touchscreen 2
toxic vapors 21
trunk, opening 24

U

unlocking, using key 23

V

vapors 21

W

wheels, chocking 15



3500 Deer Creek Road
Palo Alto, CA 94304

© 2013-2014 TESLA MOTORS, INC. All rights reserved.

All information in this document and all MODEL S[®] software is subject to copyright and other intellectual property rights of Tesla Motors, Inc. and its licensors. This material may not be modified, reproduced or copied, in whole or in part, without the prior written permission of Tesla Motors, Inc. and its licensors. Additional information is available upon request. TESLA MOTORS[®], TESLA ROADSTER[®], T E S L A[®], T[®], [®], and MODEL S[®] are registered trademarks of Tesla Motors, Inc. in the United States. TESLA[™] is a trademark of Tesla Motors, Inc. in the United States and other countries. All other trademarks contained in this document are the property of their respective owners and their use herein does not imply sponsorship or endorsement of their products or services. The unauthorized use of any trademark displayed in this document or on the vehicle is strictly prohibited.